

# 1N4007 Rectifier

TO-277

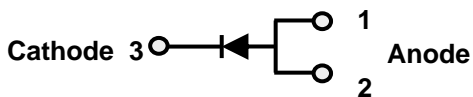

## Features

- 1. High reliability
- 2. High surge capability
- 3. High reverse voltage capability
- 4. High reverse leakage current
- 5. High forward current capability
- 6. High reverse recovery time
- 7. High forward voltage drop
- 8. High reverse recovery time
- 9. High reverse recovery time
- 10. High reverse recovery time

## Applications

- 1. Power supply
- 2. Rectifier
- 3. Diode
- 4. Diode
- 5. Diode
- 6. Diode
- 7. Diode
- 8. Diode
- 9. Diode
- 10. Diode

### Maximum ratings and electrical characteristics (T<sub>J</sub> = 25°C unless otherwise noted)

A		D		E		F	
G		C		G			
B		1		2			
A		1		D		3	
B		E		E		D	
E		3		A		C	
		R		JC			
				E		A	
		2		E		MAX.	
		2		E		56	
		2		E		50	
		2		E		71	
		2		E		65	
		2		E		5	
		2		E		5	

(1) Pulse test: 300 μs pulse width, 1 % duty cycle  
 (2) Pulse test: Pulse width 4.0 ms



**RATINGS AND CHARACTERISTICS CURVES** 7\$ f & XQOHV\QRWKB UZLVH

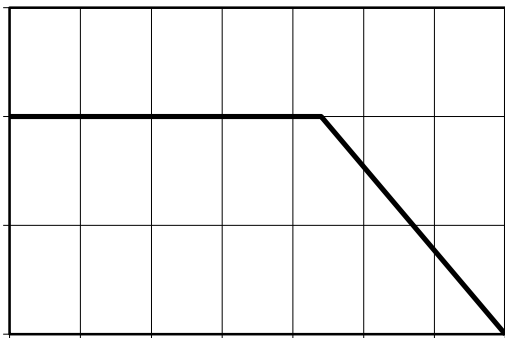

7F & DVH 7HPS

μCE v š OE š]vPU

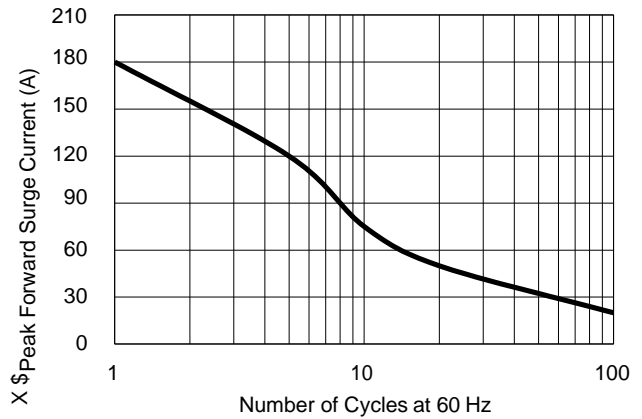

X\$Peak Forward Surge Current (A) AE]uμu Z % š]š]À ^μCE P μCE CE

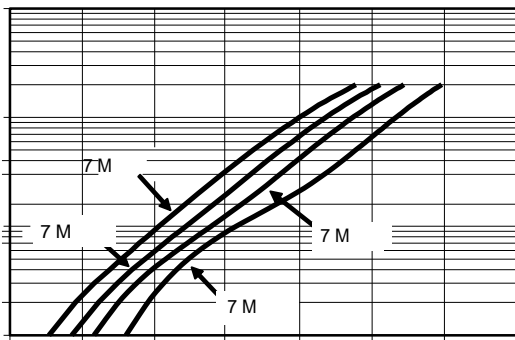

91 , QVWDQWDQ HFRXOW)DRJH Z DRUG

dÇ%] o &}CEÁ CE s}oš P

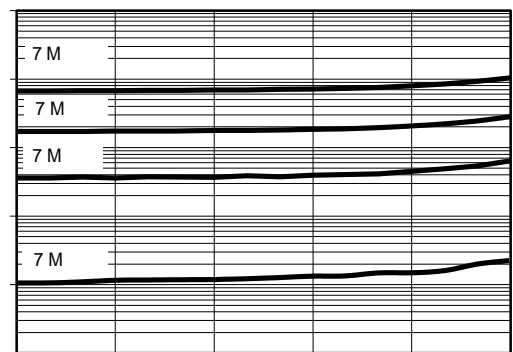

95 5HYHUVH 9ROWDJH 9ROWV

dÇ%] o Z À CE • μCE CE v š

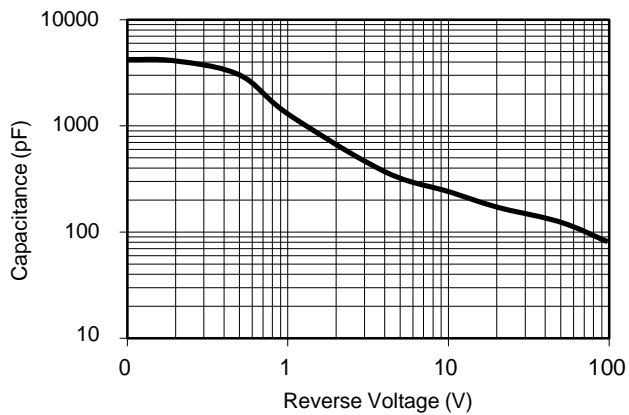

dÇ%] o :μv š]}v %] š v

**PACKAGE OUTLINE DIMENSIONS**

72

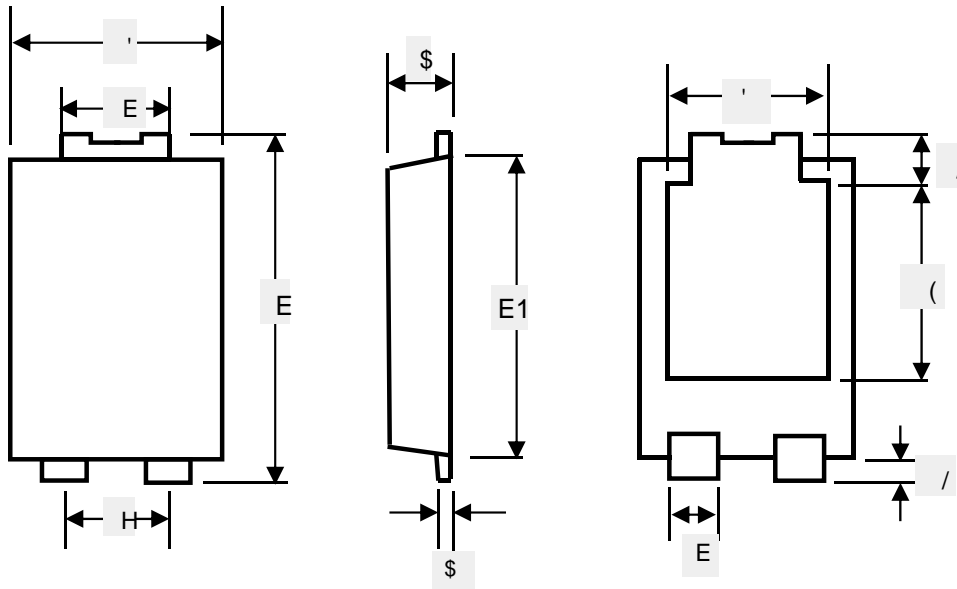

72 PHFKDQLFDO GDWD

72 **Suggested Pad Layout**

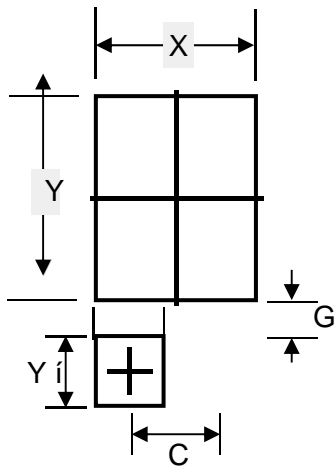

81, 7	&	*	;	;	
PP	PLQ				
PLO	PLQ				

**Marking Information**

7<sub>A</sub> . 7 6 3 9 6 3 5 H I H U U H G  
W R D V 9

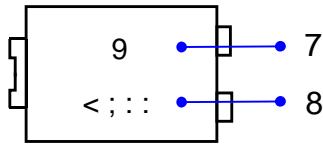

8<sub>A</sub> 4 5 Æ

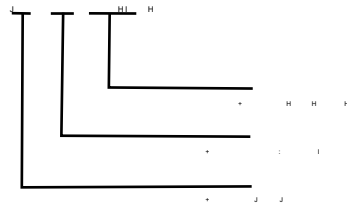

**Packaging Information**

5 H H O ' L P H Q V L R Q V

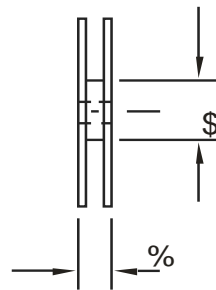
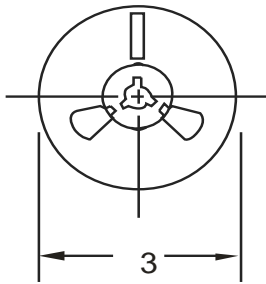

, Q V L G H % R [

2 X W V L G H % R [

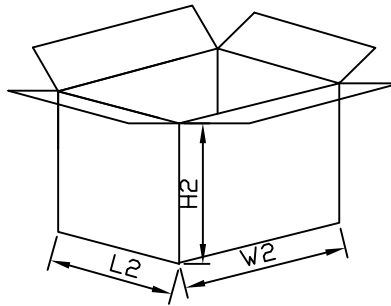
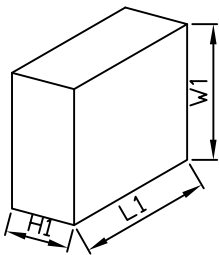

**Packaging Information**

1 2	8 1 ,	5 H H O ' L P H Q V L R			, Q V L G H % R [			2 X W V L G H % R [		
6 L ] H	PP	&	\$	%	/	:	+	/	:	+
4 7 <	3 & 6	6 P D O O H V W S D F N D J H			3 & 6 U H H O			3 & 6 3 & 6 H F B O W R Q W R W D O		
1 R W H		7 R O H U D Q F H P " P P			P P " P P			P P " P P		