

7UHQFK 026 %DUULHU 6FKRWWN\ 5H

763 9 63
TO-277

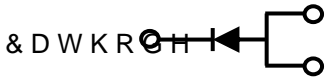

&DWKRCH \$QRGH

)HDWXUHV

‡ \$GYDQWUHQFK WHFKQRORJ\ \\
‡ /RZRUZVROWDJH GURS
‡ /RZRZURVVHV
‡ +LJHILFLHQF\ RSHUDWLRQ
‡ /HDGH)HLQLVK &RPSOLDQW

\$SSOLFDFWLRQV

‡ '& '& &RQYHUWHUV
‡ \$& '\$GDSWRUV
‡ 6ZLWFKRZHXSSOLHV
‡)UHHZKHHLRQJ

0D[LPXP UDWLQJV DQG HOHFWULFDJ& FXODDWHVHUQRWHV

3DUDPHWHU		6\PERO	/LPLW	8QLW
0D[LPXP SHSHVSHUNYHYURQWDJH		9550		9
0D[LPXPYHURJHZDUG UFXEWHIQWG		,) \$9		\$
3HDN IRVZDUEBUUHQW VLQRDQZDYH VXSHULP&DCHRS&GGLRGH		,) 60	0	\$
2SHUDMXQRDQQRWRUDJH WDESHUDW XOH 767			WR	f &
7\SLFDO WKHUPDO UHVLVWDQFH SHU		GLSR&H	ORXQWHG RQ)5	3&f% :
,QVWDQWDQHRROWRUJZDUG SHGLRGH	,) \$	7- f &	7 < 3	0\$;
	,) \$	7- f &		
	,) \$	7- f &		8
	,) \$	7- f &		
,QVWDQWDQHRXUUSHOMRQWH UDWHYHYURQWDJH		7- f &		X\$
		7- f &	5	P\$

1RWHV

3XOVH WHVVSXOVH ZLGWK GXW\ F\FOH

3XOVH WHVW 3XOPH ZLGWK 0

5\$7,1*6 \$1' &+\$5\$&7(5,67,&6 &7859(6f& XQOHVQRWKB UZLVH

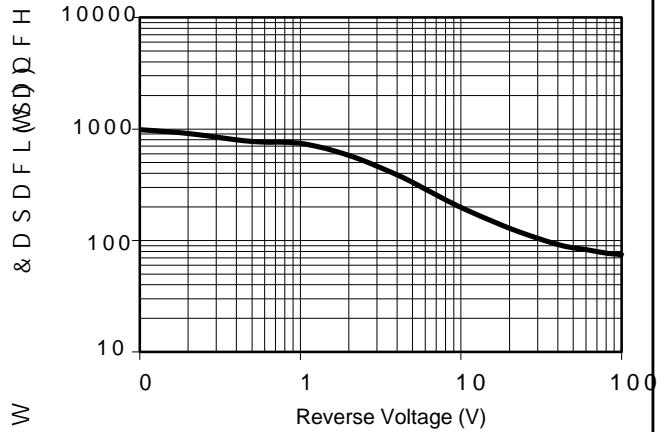
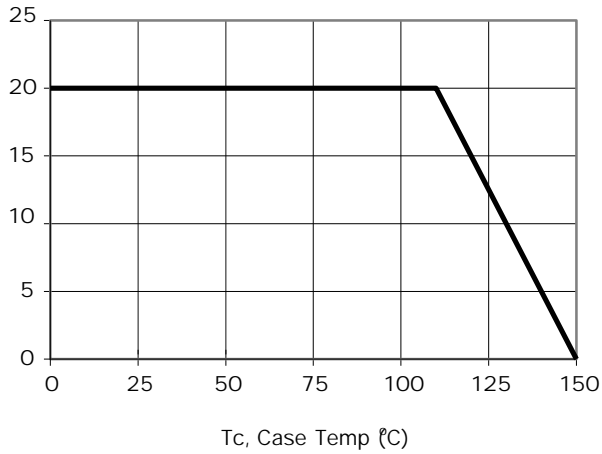

, I, QVWDQWYBQZHXU(\$QW

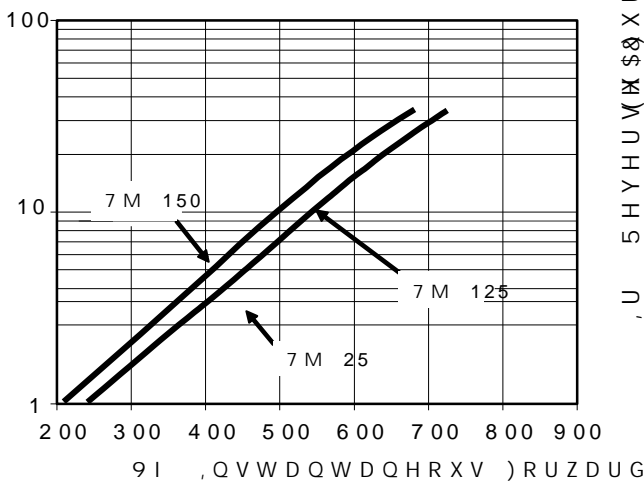

, U 5HYHUV(\$XUHHQW

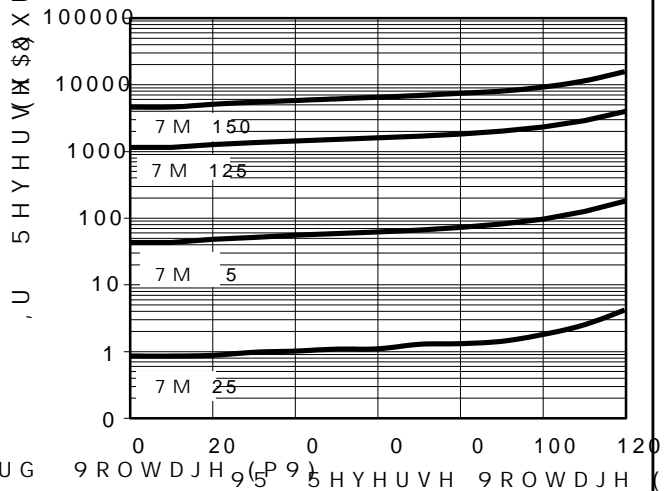

9I ,QVWDQWDQHRXV)RUZDUG 9ROWDJH (P 9) 5HYHUVH 9ROWDJH (9ROWV)

3 \$ & . \$ * (2 8 7 / , 1 (' , 0 (1 6 , 2 1 6

TO-277

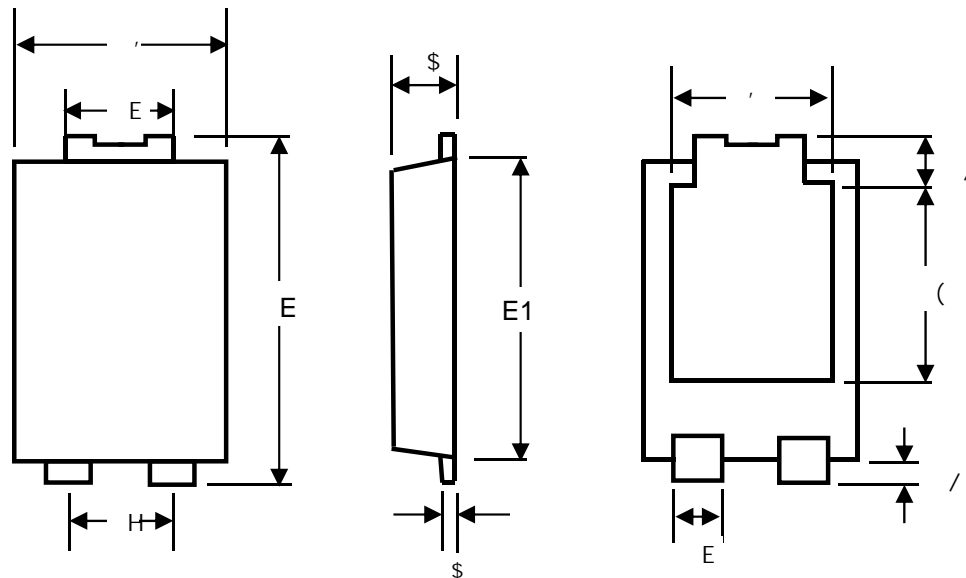

7 2 M H F K D D L D F W D

8 1 , 7		\$	\$ 2	E 1	E 2	'	' 1	((1	(2	/	/
P P	P D	3		1 0	1	3			5 5		1 0	
	P L Q	1		0	1	3	3 0 5		5 3	3 5 5		5
P L Q	P D											
	P L Q											

7 2 2 6 X J J H V W D H G \ R X W

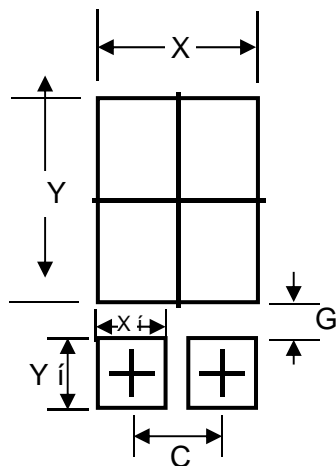

8 1 ,		&	*	;	;	<	<
P P	P L Q						
P L Q	P L Q						

0DUNLQJ ,QIRUPDWLRQ

73URGXFW PRGHO 75B2H0U20G 3
WR DV 209120

83' & LQIRUPDWLRQ

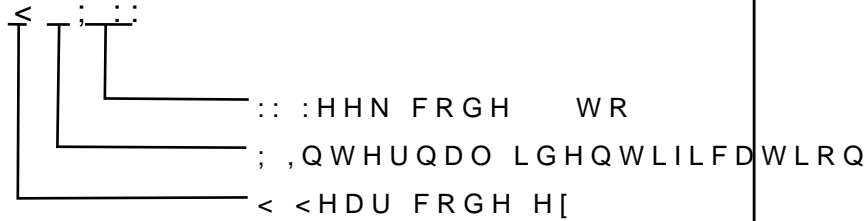
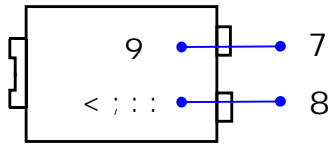

3DFNDJLQJ ,QIRUPDWLRQ

5HHO 'LPHQVLRQV

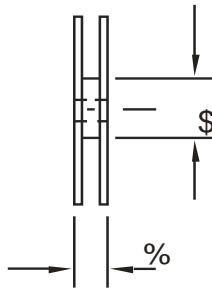
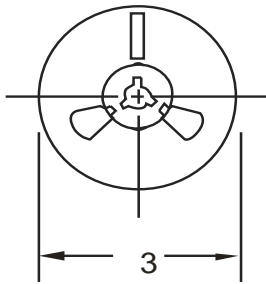

,QVLGH %R[

2XWVLGH %R[

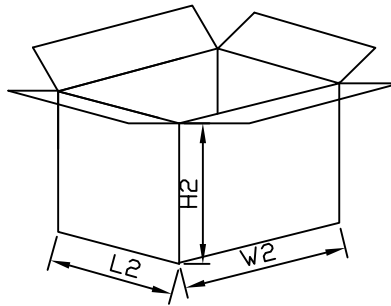
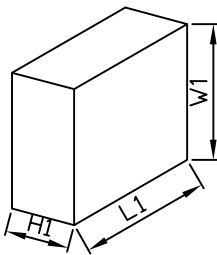

3DFNDJLQJ ,QIRUPDWLRQ

12	81,7	5HHO'PHQVLRQV			,QVLGH %R[2XWVLGH %R[
		&	\$	%	/	:	+	/	:	+
6L]H	PP									
47<	3&6	6PDOOHVW SDFNDJH			3&6 UHHO			3&6&6HFDOWRWRW		
1RWH		7ROHUDQFH PP" PP			PP" PP			PP" PP		