

7 U H Q F K 0 2 6 % D U U L H U 6 F K R W W N \ 5 H

Features

- ‡ \$ G Y D Q W F H G Q F K W H F K Q R O R U \
- ‡ / R Z R U Z D Y R G W D J H G U R S
- ‡ / R Z R Z I O R V V H V
- ‡ + L J H I L F L H Q F \ R S H U D W L R Q
- ‡ / H D G H H L Q L V K & R P 6 O L D Q W

Applications

- ‡ ' & ' & & R Q Y H U W H U V
- ‡ \$ & ' & \$ G D S W R U V
- ‡ 6 Z L W F X R Q H X S S O L H V
- ‡) U H H Z K H H L Q G Q J

Maximum ratings and electrical characteristics (TJ = 25°C unless otherwise noted)

3 D U D P H W H U	6 \ P E R O	/ L P L W	8 Q L W
0 D [L P X P H S H V S H M U N Y Y H Y U R O W D J H	9 5 5 0		9
0 D [L P X P Y H U D R U H Z D U G U F X E W H I Q W G	,) \$ 9		\$
3 H D N I R U V Z D U F S U U H Q W V L Q D O H Q Z D Y H V X S H U L P S Q M H V C H R S E G L R G H	,) 6 0		\$
2 S H U D M X Q E D Q L Q W R U D J H W D E S H U D W X 0 H 7 6 7 *		5 W R	
7 \ S L F D O W K H U P D O U H V L V W D Q F H S H U	G L S G H 0 R X Q W H G R Q) 5		3 & f % :

7 < 3 0 \$;

, Q V W D Q W D Q H R R 0 W R U Z D U G
S H G L R G H

9)

1 R W H V

3 X O V H W H V V S X O V H Z L G W K G X W \ F \ F O H

3 X O V H W H V W 3 X O P W H Z L G W K 0



RATINGS AND CHARACTERISTICS CURVES (TA = 25 °C unless otherwise noted)

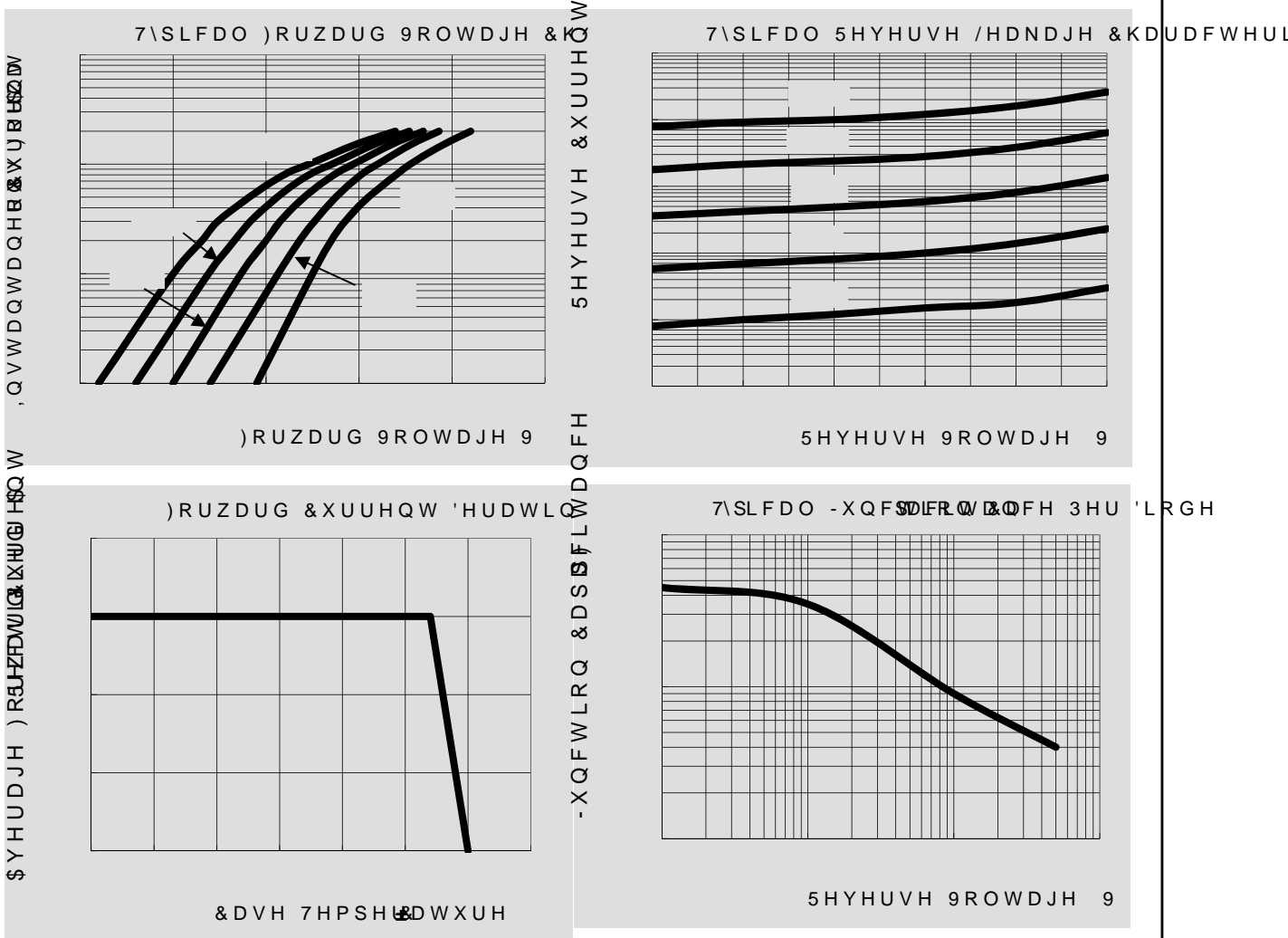

3 \$ & . \$ * (287 / , 1 (' , 0 (16 , 2 1 6

TO-277

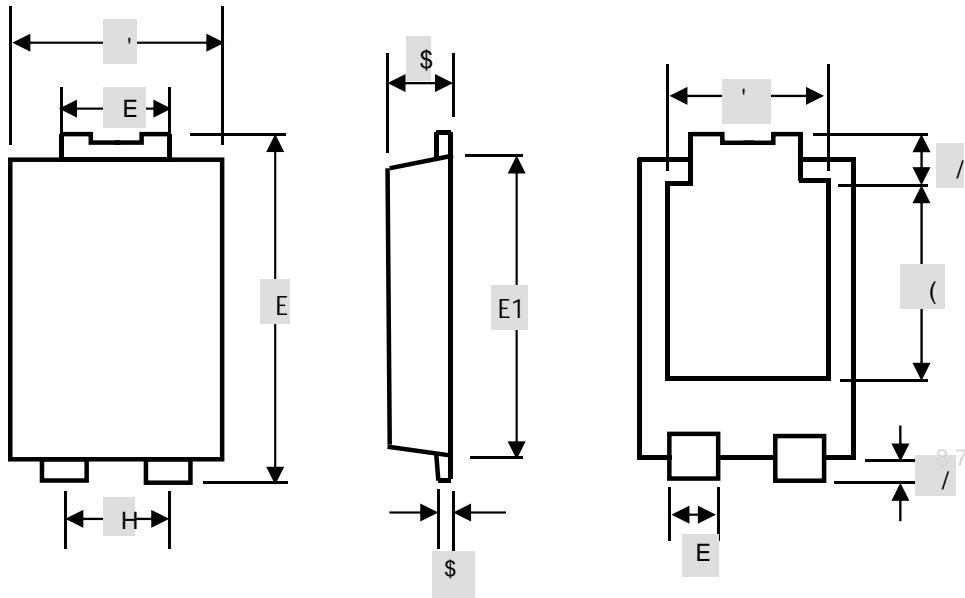

MB

7 2 MYW \ U b] W U ` D U h U

81,7



7 6 315L65SP

18-JUL-2014

Marking Information

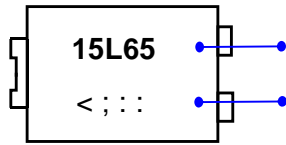

3 URGXFW PRGHO 7 6 315L65SP 5 HIHUUH
 WR DV 15L65
 3' & LQIRUPDWLRQ

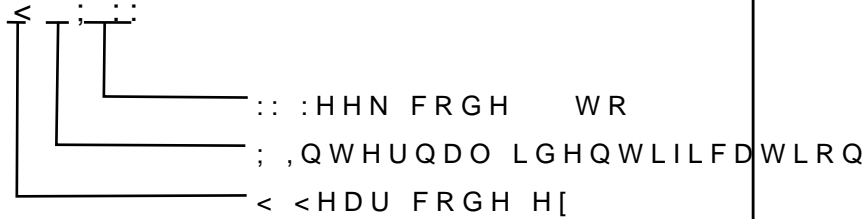

Packaging Information

5HHO 'LPHQVLRQV

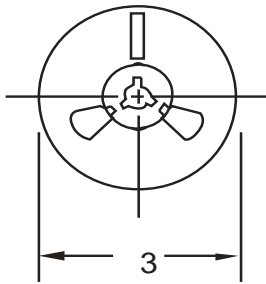

,QVLGH %R[

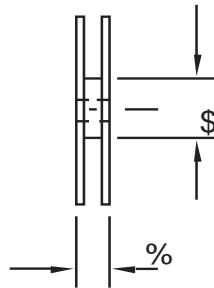

2XWVLGH %R[

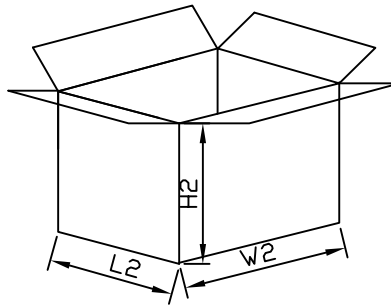
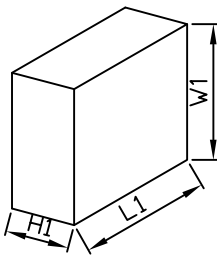

Packaging Information

12	81,7	5HH'QPHQVLRQV	,QVLGH	2XWVLGH %R[
		\$	%	/ : +
6L]H	PP			/ : +
47<	3&6	6PDOOHVW SDFNDJH	3&6 UHHO	3&6&6JHFOURQRW
1RWH		7ROHUDQFHPP"PP	PP"PP	PP"PP